

Photovoltaic Solar Inverter Series ES

ES2200 / ES3300 / ES4200 / ES5000

Operating Manual V. 2.1 UK



Artikelnummer SLWRABSI2K0WD000
SLWRABSI3K0WD000
SLWRABSI4K0WD000
SLWRABSI5K0WD000

Legal Notice

Copyright © 2009

All rights reserved.

The manual is protected by copyright law.

EFFEKTA Regeltechnik GmbH possesses the copyright.

All used trademarks are the property of their respective owners.

EFFEKTA® is a registered trademark of EFFEKTA Regeltechnik GmbH.

EFFEKTA Regeltechnik GmbH

Rheinwaldstraße 34
78628 Rottweil, Germany

July 2010

We reserve the right to make technical and optical changes as well as printing errors.

Safety and the Environment

Avoid personal injury / property damage

- Please read this operating manual carefully to familiarise yourself with the device.
- In particular, heed the information regarding the installation and commissioning of the device.
- Only operate the product in an appropriate and proper way and within the parameters stated in the Technical data.
- Only perform maintenance and service work that is described in the documentation. Observe the required steps. Only use original replacement parts from EFFEKTA.

Protecting the environment

- Send the product back to EFFEKTA after the end of its useful life. We will ensure environmentally friendly disposal.

About this document

- The abbreviation PV in this manual stands for photovoltaic.
- Read this documentation carefully and make yourself familiar with the product before using it. Store this documentation in an easily accessible place to refer to it if necessary. Please pass this documentation on to later users of the product.
- In this document, the following conventions are observed:

Symbol / Image	Explanation / Example
	<p>With the signal word Attention!:</p> <p>Warning of dangerous electrical voltage.</p>

**With the signal word Attention!:**

Warns of dangers that could lead to serious physical injuries if the identified precautionary measures are not taken.

**With the signal word Caution!:**

Warns of dangers that could lead to slight physical injuries or property damage if the indicated precautionary measures are not taken.



Identifies instructions, additional information and tips.



Identifies instructions for recycling.



Identifies components that are subject to the Electronic Scrap Regulation.



Identifies components or parts that must be disposed. Do not throw these in the household waste.



Requirement that must be fulfilled:

- ✓ The DC circuit breaker is set to OFF.

1

Steps are listed in numbers if a certain sequence of actions must be observed.

- A step is not numbered if the action only involves one step or if the step is optional.

- " ... " Sample entries are in quotes:
The value "0" causes the following...

- Bold text** Elements on the programme surface or device display:
The device description appears in **File list of devices/parameters**.

- ...>... Functions/paths within a menu:
Start > All programmes > EFFEKTA > XYZ Software.

- [] Keys that cause an action to start:
Confirm the entry with [OK].

- ESC Keys on the device or keypad:
Press ESC.

Table of Contents

1. INTRODUCTION.....	8
2. SAFETY	9
2.1 General safety instructions	9
2.2 Information about housing	10
2.3 Information about PV module	10
2.4 Information about mains connection.....	11
3. OVERVIEW OF PRODUCT	12
3.1 Dimensions	12
3.2 Display and connections	13
4. INSTALLATION.....	14
4.1 Checking the device and scope of delivery	14
4.2 Ambient conditions for installation	16
4.3 Installation of the PV solar inverter	18
5. ELECTRICAL INSTALLATION	20
5.1 Connecting AC power cable	20
5.2 Connecting PV module	24
5.2.1 Requirements of PV module	24
5.2.2 Attaching cables for PV module	24
5.2.3 Overview of cables for the PV module	27
6. CONTROL PANEL.....	28
7. COMMISSIONING.....	30
7.1 Starting device for the first time	30
7.2 Country settings, operating mode settings and ID settings	31
7.3 Commissioning the PV solar inverter.....	33
7.4 Checking measurement readings and numbers.....	34
7.5 Operating status of the PV solar inverter.....	37
8. COMMUNICATION INTERFACES	39
8.1 Standard communication interface	39
8.1.1 Settings for the RS-232 interface	39
8.1.2 Pin assignment for the RS-232 interface	39
8.2 Solar-Log™	39
8.3 Optional data cards.....	40

8.3.1	Installing communication card.....	40
8.3.2	RS-485 card	42
8.3.3	Connecting the RS 485.....	43
8.3.4	USB card.....	45
8.3.5	Relay contact of card (DCE-B card).....	46
8.3.6	SNMP card.....	47
9.	STATUS DIAGNOSIS AND TROUBLESHOOTING	48
9.1	Error codes and explanations	48
9.2	Mains error alarm codes and explanations.....	51
10.	SERVICE.....	54
11.	TECHNICAL DATA.....	55
11.1	Device specifications	55
11.2	Block diagram of ES2200 / ES3300	58
11.3	ES4200 / ES5000 Block diagram	59
11.4	Scope of delivery / (optional) accessories	60
12.	DECLARATION OF CONFORMITY	63
13.	WARRANTY AND LIABILITY.....	64
13.1	Warranty conditions	64
13.2	Limitation of liability.....	65

1. Introduction

Thank you for deciding to purchase a photovoltaic solar inverter from the ES series.

Many years of experience in the production of power supply devices have gone into the construction of this device. We hope that this device supports your solar system for many years without a glitch.

The PV solar inverter is a complex electronic system that must deal with many regional supply conditions. If you have questions about this, or if faulty operation occurs, please do not hesitate to contact your authorised dealer. He will try to help you as quickly and easily as possible.

2. Safety

2.1 General safety instructions

This operating manual contains important instructions that you must follow during the installation and operation.

For this reason, please read and heed the operating manual and the safety instructions provided in this chapter before you take any additional steps.

Work on the device is to be performed solely by authorised professional staff.

**Attention!**

Faulty operation and incorrectly performed work can cause serious injuries and property damage.

The installation of your PV solar inverter in accordance with the respective requirements may only be handled by authorised professional staff.

**Attention!** Danger of electric shock

Do not perform any work on the PV solar inverter if this work is not described in this operating manual.

The PV solar inverter contains capacitors. These require at least 12 minutes to be discharged to a safe level if the supply of power is interrupted.

**Attention!** Danger of burns

Some components of this device can reach high temperatures.

Do not touch these components!

2.2 Information about housing



Attention!: Danger of electric shock

Only open the covers of the connections on the PV solar inverter when the device has been separated from the supply of electricity and has no voltage.

The covers and the housing may only be opened by authorised professional staff.

2.3 Information about PV module

Before you connect the PV module, check whether the voltage parameters in the manufacturer's Technical data correspond to the actual parameters.

When reading the voltage, be sure that the PV module achieves a higher open circuit voltage at lower temperatures and unchanged solar radiation.



At -20 °C, the open circuit voltage of the PV module may not be above 500 V. To determine the theoretical open circuit voltage at -20 °C, use the temperature factors in the data sheet of the PV module.

If the open circuit voltage of the PV module is over 500 V, the PV module may not be connected since the warranty is forfeited in such cases.



The PV solar inverter contains a monitoring unit for fault currents in accordance with VDE 0126-1-1. This unit measures the ground current of the PV module and prevents a feeding into the mains in the event of a ground fault.

2.4 Information about mains connection

The PV solar inverter may only be connected to the mains by appropriately licensed specialists.

Please contact your regional energy supplier with regard to special requirements.

Permission from the energy provider/supplier must be obtained for the connection of the PV solar inverter.

3. Overview of product

3.1 Dimensions

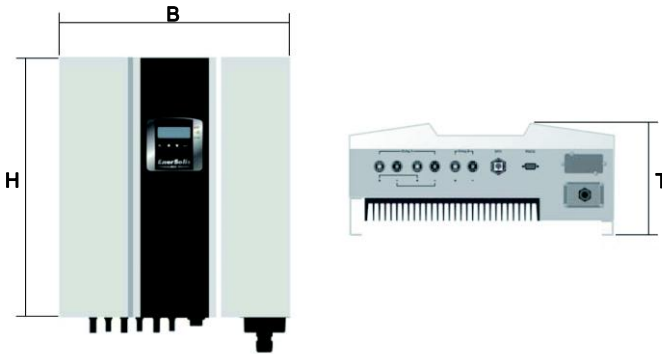

		ES2200/3300	ES 4200/5000
Width W	[mm]	455	455
Height H	[mm]	430	510
Depth D	[mm]	190	190

3.2 Display and connections

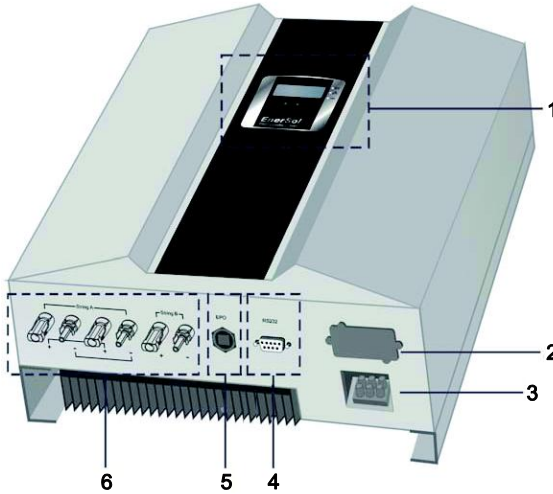

ES 4200/5000

1	Control panel with LCD & LED displays	Operation & display of operating state of PV solar inverter
2	Interface to data transmission (option)	USB, RS-485, floating contact, TCP/IP
3	Output terminal for alternating current	Alternating current output connection to power grid
4	Interface to data transmission (standard)	RS-232
5	Interface for emergency shutdown	EPO
6	Feed for PV module	Plug and socket for the connection of the solar module: ES 2200: 3 connections (1 MPPT) ES 3300: 3 connections (1 MPPT) ES 4200: 3 connections (2 MPPT) ES 5000: 3 connections (2 MPPT)

4. Installation



Please read the chapter "Safety" on page 9 before connecting the PV solar inverter.

4.1 Checking the device and scope of delivery

Check the completeness of the package and the device for any damage after receiving the PV solar inverter. Although the manufacturer ensures a safe packaging of the product, damage can nonetheless occur during transport. Inform the transport company and your dealer about damage that has occurred.



The packaging of the PV solar inverter can be recycled.

Save the packaging for future use or dispose of it accordingly.

The standard delivery for a PV solar inverter consists of:

- 1 PV solar inverter
- 1 operating manual
- 1 set of PV connectors
- 1 set of sealing caps for the PV connection
- 1 wall mounting

Dimensions for wall mounting:

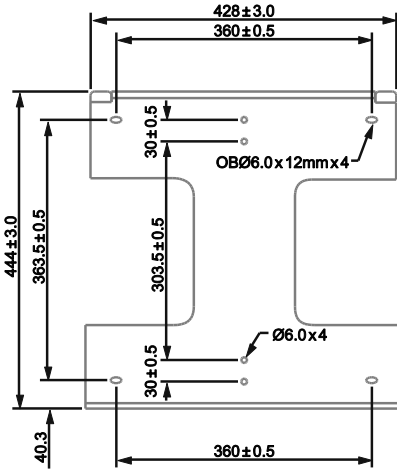

PV solar inverter ES2200 / ES3300

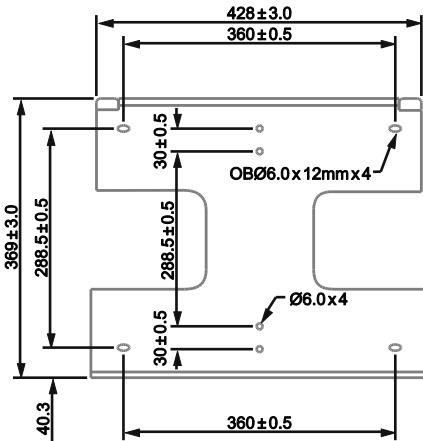

PV solar inverter ES4200 / ES5000

4.2 Ambient conditions for installation



When selecting the installation site, please consider the weight of the PV solar inverter; see chapter "Technical data" on page 55.

Install the PV solar inverter only at locations that can bear this load.

To guarantee perfect operation and a long service life, install the PV solar inverter in accordance with the following requirements.

- Select the coolest possible location for installation.
High temperatures hamper the effectiveness and shorten the service life of the PV solar inverter. If need be, install an additional cooling system in the room in which the PV solar inverter is installed.
- The PV solar inverter ambient temperature must range from - 25 °C to + 50 °C.

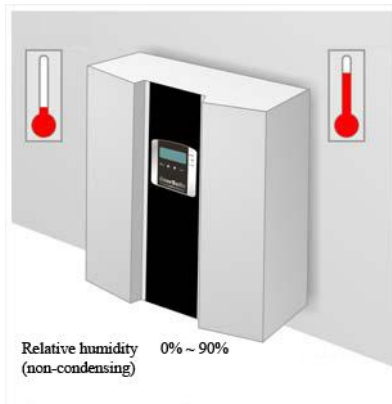

- The PV solar inverter may not be exposed to any direct solar radiation.

- The PV solar inverter is constructed for vertical assembly. Never assemble the PV solar inverter in a horizontal position and make sure it does not tilt forward if assembled outdoors.

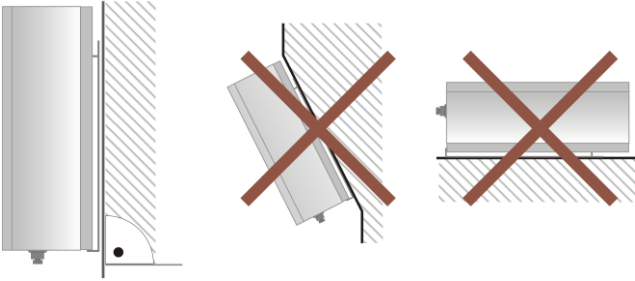

- When selecting the assembly location for the PV solar inverter, you must ensure that sufficient heat dissipation is possible. The following minimum amounts of free space around the PV solar inverter must be maintained:

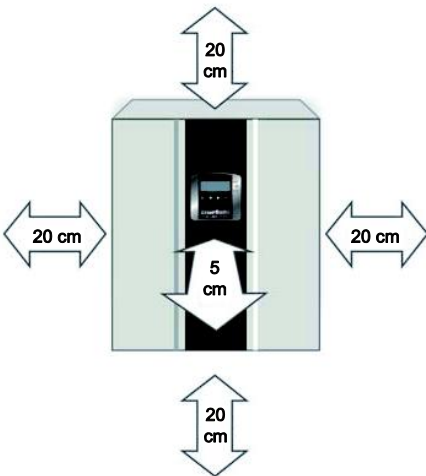

4.3 Installation of the PV solar inverter



Use the supplied wall mounting for the installation of the PV solar inverter.

For vertical installation, heed the weight of the PV solar inverter when selecting the material to which it will be attached; see chapter "Technical data" on page 55.

You can use the wall mounting to mark the holes for drilling. If you do not want to use the wall mounting as a template for the drill holes, please note the dimensions of the wall mounting in chapter "Checking the device and scope of delivery" on page 14.

To mount the PV solar inverter, proceed as follows:

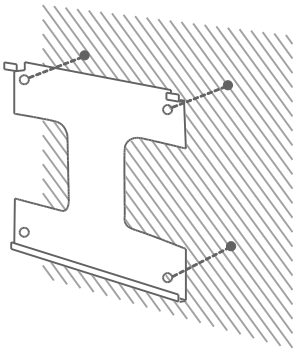

- 1 Mark the positions for the drill holes on the wall.
- 2 Drill the holes in accordance with the screws you have selected.
- 3 Screw on the wall mounting.

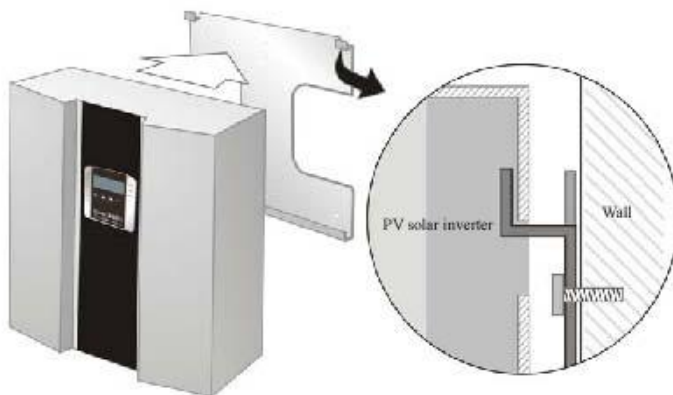

- 4 Hang the PV solar inverter on the wall mounting.
Use the upper carrier plate so that the PV solar inverter cannot slip.
- 5 Check whether the PV solar inverter is safely attached to the mounting.

5. Electrical installation



Attention! Danger of electric shock

The system contains components with high voltage and high current. For this reason, improper handling can lead to accidents with deadly consequences or property damage.

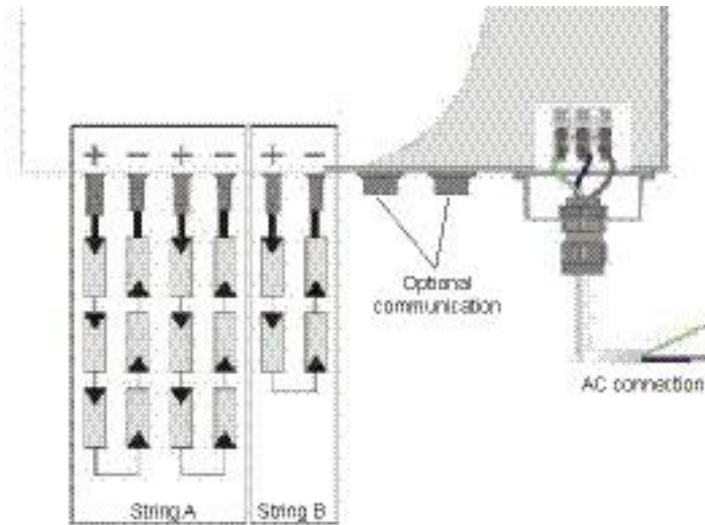

Wiring of PV solar inverter Example (ES4200/5000)

5.1 Connecting AC power cable



Connection conditions

- Heed the connection conditions of your mains operator.
- Pay attention to the locally required country settings on the PV solar inverter; see chapter "Country settings, operating mode settings and ID settings on page 31.



Ground fault circuit breaker

The PV solar inverter is equipped with an integrated fault current monitoring unit.

If an external RCD or FI circuit breaker is required, please use a type B circuit breaker which triggers above a 100 mA fault current.



Cable line layout

- The mains line resistance should not exceed 0.1 Ω.
- Your electricity supplier must calculate the maximum line lengths after taking the cross section of the line into consideration.

The following cable sizes are recommended for the AC power cables:

Model	Line cross section
ES2200 / ES3300	4 mm ²
ES4200 / ES5000	6 mm ²

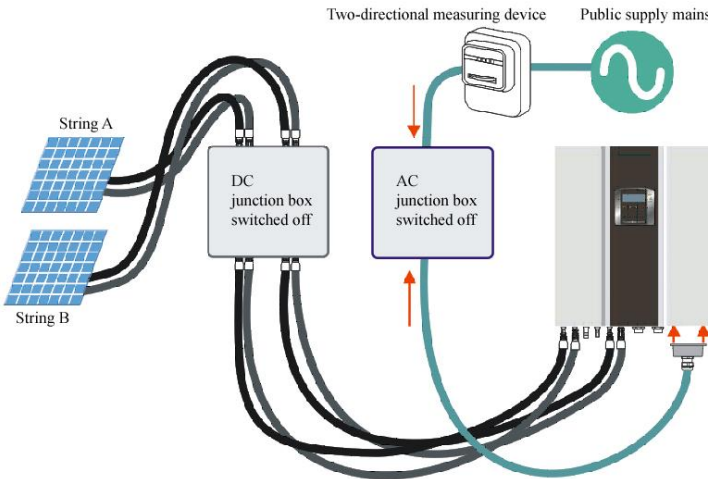

Overview of the cable lines

To connect the AC cable, please proceed as follows:

- 1 Measure the voltage and frequency of the supply mains.



Supply voltage and frequency can vary from country to country.

- 2 Make sure that AC and DC circuit breakers are in the OFF position before you attach the cables to the PV solar inverter.
Don't turn on this switch before you have completely attached the cables.

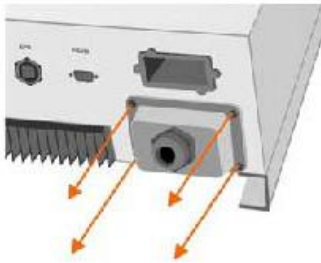

- 3 Loosen the screws of the cable inlet and remove it.

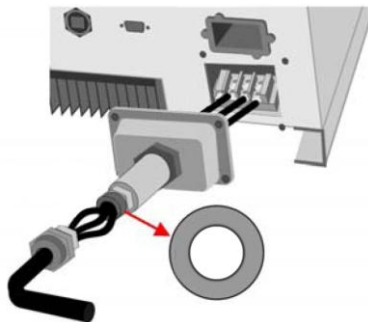

- 4 Insert the supply cable through the cable inlet and connect the wires as indicated on the splitter:

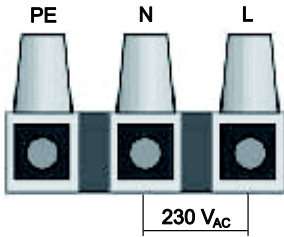

- L Conductor
- N Neutral
- PE Grounding conductor (yellow-green)

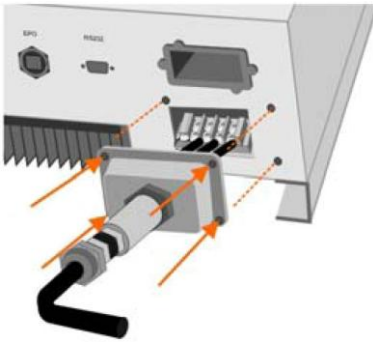

Attention! Danger of electric shock

The absence of grounding can lead to dangerous electric shocks.

Make sure that the grounding conductor is correctly connected before you start operating the PV solar inverter.

- 5 Position the cable inlet and screw it to the housing of the PV solar inverter.

5.2 Connecting PV module

5.2.1 Requirements of PV module

The PV solar inverters ES4200 and ES5000 use 2 MPP trackers. Tracker A can be connected to up to 2 strings and Tracker B can be connected to one string.

The PV solar inverters ES2200 and ES3300 have only one Tracker, that can be connected to up to 3 strings. The maximum DV input voltage of 500V and the maximum input current must not be exceeded.

The connection cable of the PV module must be designed for these connections.

A set of connectors for connecting the line ends of a string is included in the scope of delivery. The type descriptions for other PV connectors are:

- Connection plug: PV-KST4/6II-UR
- Coupling connector: PV-KBT4/6II-UR

You will find more information online at www.multi-contact.com.

5.2.2 Attaching cables for PV module

The PV solar inverter is equipped with PV quick connecting terminals. These permit the connection of up to two strings for ES2200 and ES3300 and up to three strings for ES4200 and ES5000.



The connection of additional strings is possible. These must be externally connected.

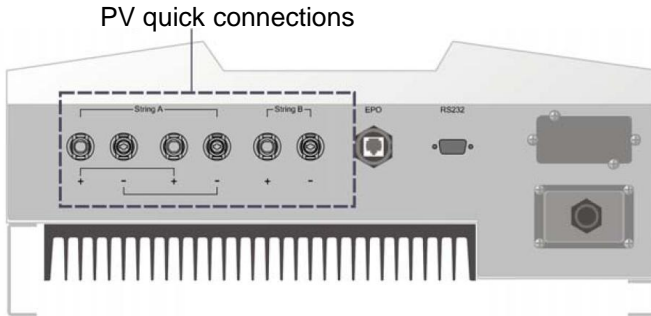

Attention! Danger of electric shock

Make sure that the DC circuit breaker is located in the position OFF before you connect the PV module.



Attention! Danger of property damage

In determining the required panels in the PV string, please consider the following points:

- To avoid damage to the PV solar inverter, make sure that the output on the PV module is never above $500 V_{DC}$.
Make sure that the maximum open circuit voltage U_{OC} of each PV string is less than $500 V_{DC}$. Voltage of over $500 V_{DC}$ may damage the PV solar inverter.
- Make sure that the short circuit current of the module is not greater than the measurement on the PV solar inverter.
- To achieve the maximum energy output from your PV module, make sure that the voltage does not fall below $150 V_{DC}$ at maximum Mpp performance or exceed $450 V_{DC}$.
- The following applies for the PV solar inverters ES4200 and ES5000: To achieve the greatest effectiveness, both trackers should be laid out roughly symmetrically for the purpose of performance.
- Within one tracker, only modules of the same type with the same power can be used.



Important: For ES4200 and ES5000 the best efficiency will be obtained when both trackers have symmetric power configuration.

To connect the PV module to the PV solar inverter, proceed as follows:

- 1** Test whether the generator terminals have the correct polarity and do not exceed the maximum voltage for each string.
- 2** Connect the positive (+) wire of the PV string 1 to the positive quick connection terminal on the PV solar inverter.
- 3** Connect the negative (-) wire of the PV string 1 to the negative quick connection terminal on the PV solar inverter.
 - Repeat steps 2 and 3 for other PV strings.
- 4** Check whether all wires and contacts have been connected correctly.
- 5** Cover the unused sockets of the DC input with the supplied protective caps.

5.2.3 Overview of cables for the PV module

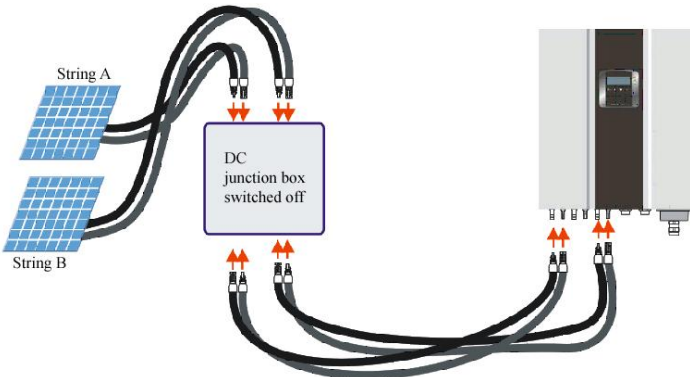

Overview of cable lines with two strings (ES4200, ES5000 via 4-pole DC breaker for respectively one string at tracker A or B.

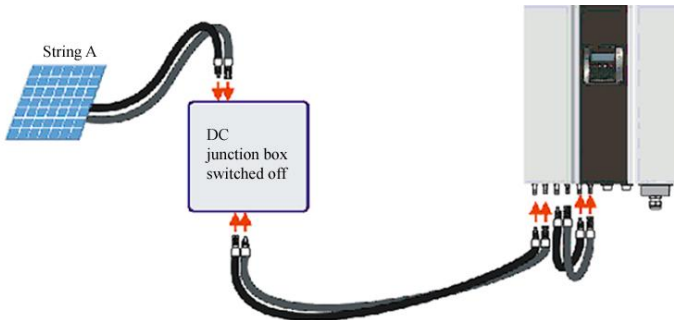

Overview of cable lines with one string for ES4200 or ES5000 in parallel mode via 2-pole DC breaker (all modules are mounted to one string before connected to the DC-breaker.



In connecting with only one string, you must switch the operating mode in the configuration to "Parallel"; see chapter "Country settings, operating mode settings and ID settings on page 31.



Be aware that ES2200/3300 offer only one tracker with connectors for three identical strings (internal parallel). If you connect single strings separately you need a corresponding DC-breaker for more strings (4-pole / 6-pole).

6. Control panel

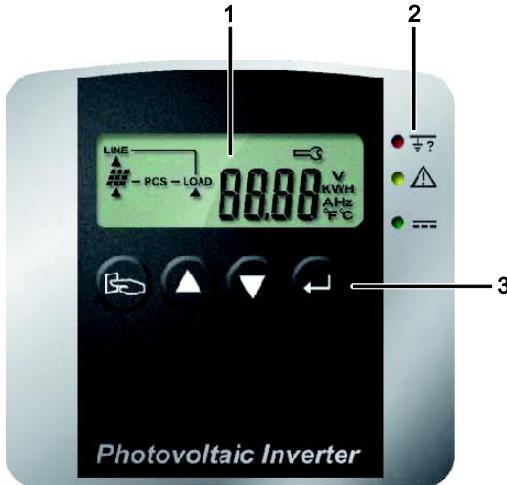

1 LCD display

LINE

Power source



Service operation



Solar cells

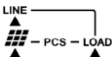

Flow chart of the PV solar inverter in operation



4-digit measurement display

2 LED display



Red LED lights up constantly - indicates a ground fault or an isolation fault at the DC input.



Yellow LED lights up constantly - indicates that the supply (voltage, frequency, etc.) does not correspond to the entered standard of the PV solar inverter.



- Green LED lights up constantly - indicates that the performance of the solar cells is greater than 5 % of the nominal performance of the solar inverter.
- Green LED blinks - indicates that the performance of the solar cells is less than 5 % of the nominal performance of the PV solar inverter.

3 Operating keys



Confirm a change to the settings of the PV solar inverter.



Continue to next page or change the settings of the PV solar inverter.



Return to the previous page or change the settings of the PV solar inverter.



Special function Log in / Log out.

7. Commissioning



Attention! Danger of electric shock

Check the following points before you start up the PV solar inverter:

- The housing is safely screwed in place.
- The DC cables (PV strings) are correctly connected and that unused DC connection terminals on the bottom of the housing are covered with safety caps.
- The AC cable is connected correctly.
- The AC switch is OFF.

7.1 Starting device for the first time

- 1 Switch on the voltage of the PV string by turning on the DC circuit breaker.

The PV solar inverter starts automatically when the voltage reaches 120 V_{DC}. All LEDs light up. The following is shown on the LCD display:



Display A

After 3 seconds the LCD display changes from Display A to Display B1 (DC voltage) and Display B2 (alarm code).

The green LED blinks to indicate that the output performance of the alternating current is below 5 % of the nominal performance.

The yellow LED lights up constantly and indicates no power.



Display B1

Display B2



7.2 Country settings, operating mode settings and ID settings

**IMPORTANT!**

SETTINGS ALREADY CONFIGURED IN FACTORY.
CHANGES ONLY TO BE MADE USING LAPTOP AND SETTING TOOL.

**Caution!** Danger of property damage

False country settings can compromise your mains electricity, cause the solar inverter to malfunction and lead to the termination of your authorisation to operate the device.

**IMPORTANT!**

Before changing the settings assure that the AC switch is OFF.

This page is intentionally left blank.

7.3 Commissioning the PV solar inverter

- 1 Check whether the DC circuit breaker is switched on and set it to ON if need be.
- 2 Set the AC circuit breaker to ON.
- 3 Wait 30 seconds (legally required waiting period).

The LCD display changes between the Displays C1 (DC voltage) and Display C2 (alarm code). The yellow LED lights up and the green LED blinks.

Display C1



Display C2



After 30 seconds, the yellow LED goes off and the green LED blinks again. The LCD display shows Display D.

Display D



After 5 seconds, the LCD display shows Display E. The green LED lights up constantly.

Display E

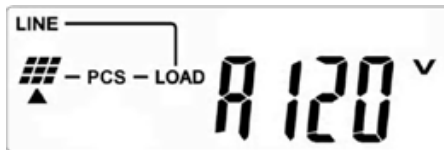

If the PV solar inverter is defective (short circuit), an error code or the error status will appear on the display.

Display F



Information!

A list with the explanations of possible error codes can be found under "Error codes and explanations" on page 48.

If the PV solar inverter was started completely and successfully, the LCD display shows Display E.

7.4 Checking measurement readings and numbers

Via the LCD display, you can check the measurement readings and numbers set by the PV solar inverter.

- Use the ▲ key and the ▼ key to switch the displays. The measurement readings and numbers appear in the following order as you scroll down:

Display G:
Voltage of String A



Display H:
Voltage of String B



Display I:
Current of String A



Display J:
Current of String B



Display K:
Output power of String A



Display L:
Output power of String B



Display M:
PV solar inverter Output voltage



Display N:
Frequency of PV solar inverter Output voltage



Display O:
PV solar inverter Output current



Display P:
Current flow of energy



Display Q:
Total flow of energy



Display R:
PV solar inverter
Internal temperature
°F



Display S:
PV solar inverter
Internal temperature
°C



Display T:
Temperature of
cooling element °F







Display U:
Temperature of
cooling element °C



7.5 Operating status of the PV solar inverter

The PV solar inverter starts automatically when the DC power of the PV panel is sufficient.

After starting, the PV solar inverter can exhibit the following operating states.

Operating state	Display on the LCD display	Explanation
Normal		<p>The PV solar inverter works normally.</p> <p>When the delivered performance of the PV panel is sufficient ($500 V_{DC} > PV > 120 V_{DC}$), it supplies the energy to the mains.</p> <p>The green LED lights up and shows that energy is being fed into the mains.</p>
Standby		<p>If the performance is insufficient ($60V_{DC} < PV < 100V_{DC}$), the PV solar inverter switches to standby operation and searches for a connection to the mains.</p> <p>It has only limited power from the PV module to monitor the internal system state.</p>
Error		<p>The internal regulator continually monitors the system state and adjusts it.</p> <p>If the PV solar inverter registers malfunctions such as mains problems or internal errors, the display will show this, and the red LED will light up.</p>
		
EPO		<p>Emergency power off (EPO).</p> <p>The solar inverter does not receive any power from the mains in this state.</p>

Operating state	Display on the LCD display	Explanation
Shut down process	No display	If there is too little sunlight, the PV solar inverter automatically ends operation. It does not receive any power from the mains. The display and the LEDs on the control panel are out of operation.

8. Communication interfaces

You can connect external devices to the PV solar inverter and call up data. The various communication interfaces are designed for this.

8.1 Standard communication interface

The standard communication interface for the PV solar inverter consists of a RS-232 serial interface (otherwise described as EIA-232).

8.1.1 Settings for the RS-232 interface

The RS-232 interface is set as follows:

- Baud rate: 9600 bps
- Data length: 8 Bit
- Stop bit: 1 Bit
- Parity: None

8.1.2 Pin assignment for the RS-232 interface

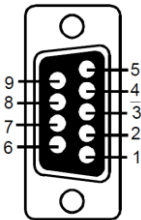

Pin 3: RS-232 Rx

Pin 2: RS-232 Tx

Pin 5: GND

8.2 Solar-Log™

EFFEKTA Solar inverters can operate with Solar-Log™. Ask our sales dept. and service for more information.

8.3 Optional data cards

If you need other interfaces than the standard communication interface, you can install an optional communication card.



ATTENTION!

The data cards can only be mounted, while the inverter is **switched off!** Mounting the data cards during operating mode can destroy the inverter.

8.3.1 Installing communication card

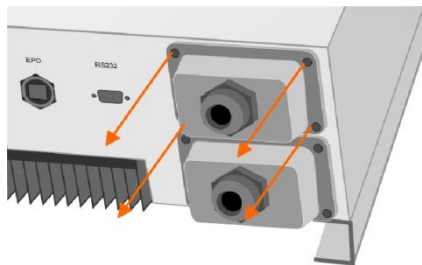

- 1 Loosen the screws and open the cover of the housing.



- 2 Insert the data cable through the cable inlet of the cover.

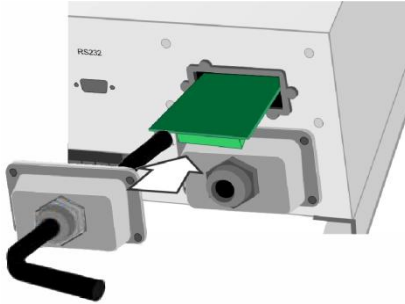

3 Connect the data cable to the communication card.

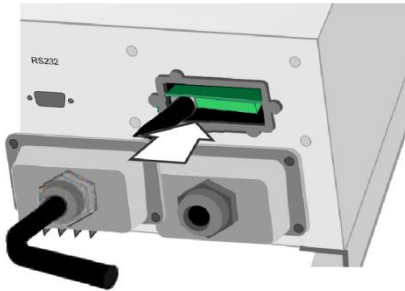

4 Insert the communication card in the receiver.

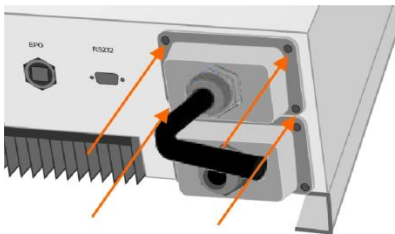

5 Place the cover back on top and tighten the four screws evenly.

8.3.2 RS-485 card



CN1 is determined for the terminating resistor.
 You can activate the function with Pin 1-2 and deactivate with Pin 2-3.
 CN2 is intended for RS-485 and CN3 for remote start-up.

Definition:

CN2		
1	2	3

1: GND
 2: A/Data+
 3: B/Data-

CN3	
1	2

1: AC+
 2: AC-

8.3.3 Connecting the RS 485

1. different inverters on one PC

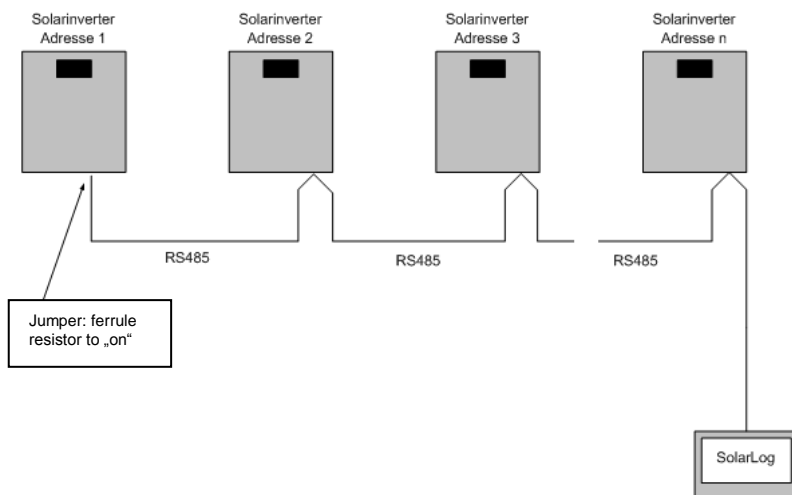

2. different inverters with Solar-Log™

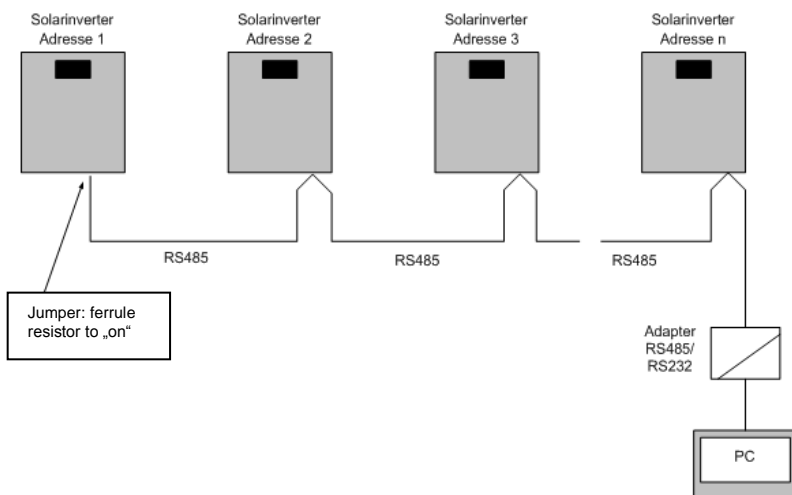

3. connected to a RS485 card (first inverter)

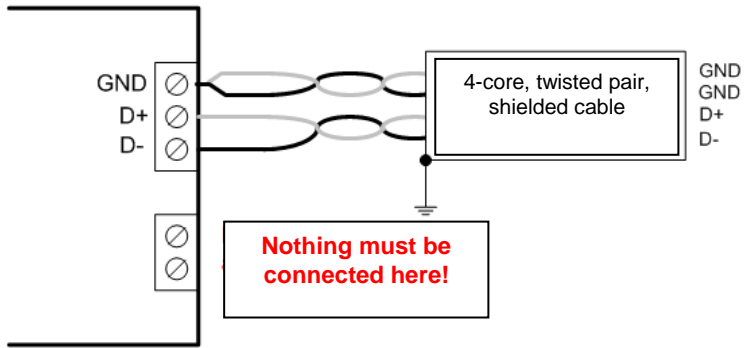

4. connected to a RS485 card (different inverters)

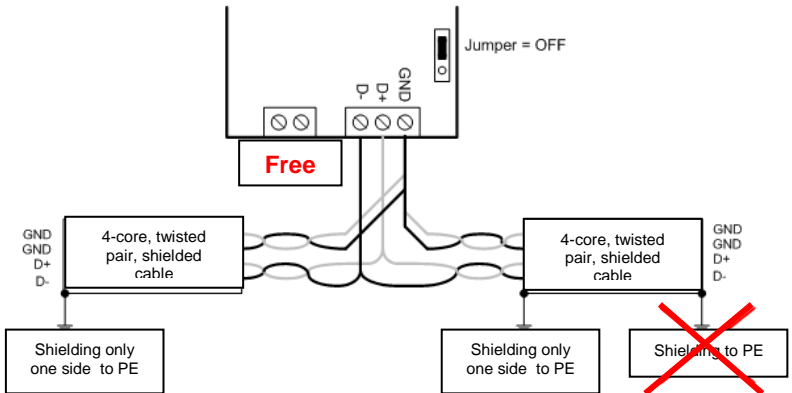

Note!

Using several inverters the RS485 – Bus will be looped through the different inverters. The bus-lines D-, D+ and GND (incoming and outgoing) are connected parallel to the terminals of the RS485-card. The shielding of the bus cables must be connected to the PE of the inverter case with only one end.

8.3.4 USB card



Definition:

- Compatible USB version 1.0, 1.5Mbit/s
- Compatible HID Version 1.0

Pin assignment for USB card:

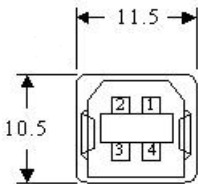

- 1: VCC (+5V)
- 2: D -
- 3: D +
- 4: GND

8.3.5 Relay contact of card (DCE-B card)



The pin assignment for the 10 pin terminal:

- Pin 1: DC input voltage inside and DC input voltage below the range
- Pin 2: at least one DC input beyond the min. limit
- Pin 3: all DC input voltages below min. limit
- Pin 4: Frequency of AC output (network) out of tolerance
- Pin 5: island solution switched off
- Pin 6: Output current of the inverter above the tolerance
- Pin 7: The heat sink temperature of the inverter is too high
- Pin 8: Common

Each relay contact can bear a load of max 40 VDC / 25 mA.

You can switch over the output signal from N.C. (normal close) to N.O. (normal open) by bridging Pin 1 and 2 or Pin 2 and 3 from JP1-5 with the jumpers.

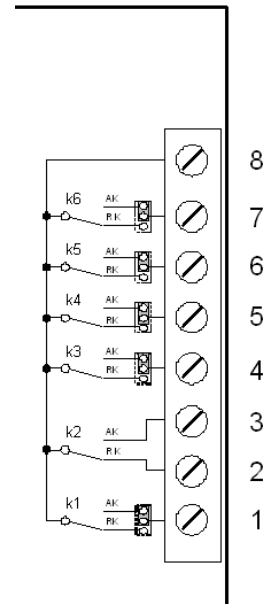

8.3.6 SNMP card



You will find more information and installation information in the documents that accompany the SNMP card.

9. Status diagnosis and troubleshooting

The PV solar inverter is equipped with a self-diagnosis system that identifies a large number of possible operating conditions independently and shows them on the LCD display. This makes it possible to quickly eliminate technical problems.

Furthermore, a distinction is possible between

- service codes concerning installation and
- service codes that relate internally to the PV solar inverter.

Whenever the self-diagnosis system identifies a particular problem, the corresponding service code is showed on the LCD display.



Information!

The following work may only be performed by trained technical staff.

9.1 Error codes and explanations

LCD display	Description	Explanation	Troubleshooting
Er00	DC_BUS pre-charge defect	The device is in the soft start mode, but after 2 seconds you do not see any stable charging voltage on the DC bus.	1 Disconnect all PV(+) - or PV(-) connections. 2 Wait a few seconds. 3 After the LCD display goes out, reinsert all the connections and check it again. 4 If the error still occurs, please contact your dealer.
Er03	Inverter voltage abnormal	The output voltage is not correct.	
Er07	DC_BUS over-voltage	The internal voltage of the DC bus is outside the tolerance.	
Er08	DC_BUS under-voltage		
Er19	DC_BUS discharge defect	The capacitors of the DC bus cannot be discharged correctly.	1. Disconnect all PV(+) - or PV(-) connections. 2. Wait a few seconds. 3. After the LCD display
Er22	Output relay defect	Malfunction on the output relay of the solar inverter.	

LCD display	Description	Explanation	Troubleshooting
Er24	Output current sense defect	Error in the output current reading.	<p>switches off, reinsert all the connections and check it again.</p> <p>4. If the error still occurs, please contact your dealer.</p>
Er25	BOOSTER_A over-current	The current in the DC mains is higher than expected.	
Er26	BOOSTER_B over-current		
Er29	PV inverter output DC current over spec.	DC current at output of solar inverter is too high.	
Er06	EPO	The PV solar inverter is in the emergency power off mode.	<p>1. Detach the connection at the EPO connection.</p> <p>2. If the error still occurs, please contact your dealer.</p>
Er09	PV inverter over-current	Over-current on the AC side. The current in the AC mains is higher than expected.	<p>1. Turn off the AC current switch; check the peripheral AC current system configurations and the mains conditions.</p> <p>2. If the error still occurs, please contact your dealer.</p>
Er11	PV inverter over-load	Over-load on the AC side. The mains load in the AC mains is higher than expected.	
Er13	PV inverter short-circuit	Short circuit on the AC side.	
Er14	PV inverter PLL defect	The PV solar inverter is not in phase with the mains electricity.	
Er10	PV inverter over temperature	The internal temperature is too high.	
Er18	Heatsink over temperature	The temperature on the cooling element is too high.	<p>1. Try to reduce the surrounding temperature.</p> <p>2. Install the solar inverter in a cooler place.</p> <p>3. If the error still occurs, please contact your dealer.</p>

LCD display	Description	Explanation	Troubleshooting
Er01	Ground fault	The fault current has reached the authorised upper limit.	<ol style="list-style-type: none">1. Disconnect the feed from the PV generator and check the peripheral AC system.2. When the reason is found, reconnect the PV panel and check the status of the PV solar inverter.3. If the error still occurs, please contact your dealer.
Er17	EEPROM ERROR on the control board	EEPROM data is faulty.	<ol style="list-style-type: none">1. Please contact your dealer.

9.2 Mains error alarm codes and explanations

LCD display	Description	Explanation	Troubleshooting
AL00	Utility voltage over-voltage	The mains voltage is higher or lower than the authorised amount.	<ol style="list-style-type: none"> 1. Wait 5 minutes. When the mains supply becomes normal again, the solar inverter starts up automatically. 2. Check the mains connection (cable and terminals). 3. Make sure the mains voltage and frequency meet the requirements. 4. If the error still occurs, please contact your dealer.
AL01	Utility voltage under-voltage		
AL02	Utility voltage over frequency	The mains frequency is higher or lower than the authorised amount.	
AL03	Utility voltage under frequency		
AL04	BOOSTER_A Input over-voltage	Under or over-voltage of the DC input.	<ol style="list-style-type: none"> 1. Disconnect all PV(+) - or PV(-) connections. 2. Check whether the PV voltage is higher or at $500 V_{DC}$. 3. If the voltage is below $500 V_{DC}$ and the problem persists, please contact your dealer.
AL05	BOOSTER_A Input under-voltage		
AL06	BOOSTER_B Input over-voltage		
AL07	BOOSTER_B Input under-voltage		

LCD display	Description	Explanation	Troubleshooting
AL08	Anti-islanding	No mains supply or mains outside the tolerances.	<ol style="list-style-type: none"> 1. Disconnect all PV(+) - or PV(-) connections. 2. Check the mains connection (cable and terminals). 3. Check the phasing and the waveform of the mains supply. 4. If the supply is normal and the problem persists, please contact your dealer.
AL13	Phase of utility defect		
AL14	Waveform of utility defect		
AL09	Inverter voltage unbalance	The waveform of the voltage of the PV solar inverter is outside the tolerance.	<ol style="list-style-type: none"> 1. Shut down the solar inverter (disconnect PV generator from the feed). 2. Start the solar inverter again (insert the PV generator into the feed). 3. If the error still occurs, please contact your dealer.
AL10	GFDI	The fault current of the grounding wire is too high.	<ol style="list-style-type: none"> 1. Disconnect the PV generator from the feed and check the peripheral AC system. 2. When the problem is resolved, reconnect the PV. Check the status of the solar inverter. 3. If the error still occurs, please contact your dealer.

LCD display	Description	Explanation	Troubleshooting
AL11	Isolation fault	The isolation between the PV connections and the earth is less than 1M Ω .	<ol style="list-style-type: none"><li data-bbox="725 256 978 312">1. Disconnect all PV(+) - or PV(-) connections.<li data-bbox="725 328 978 448">2. Check the impedance between PV(+), PV(-) and the ground (must be more than 2MΩ).<li data-bbox="725 464 978 552">3. If the error occurs again, please contact your dealer.

10. Service

There are no parts on the PV solar inverter that have to be maintained by the customer.

Clean the device at regular intervals with a dry, soft towel to avoid an accumulation of dust.

In particular, clean the cooling fins on the back of the device.

Service hotline and contact addresses

If unexpected problems occur with the PV solar inverter or you need safety information, please contact our service hotline:

- Phone number: +49 (0) 741 17451-0
- Fax number: +49 (0) 741 17451-29

If you cannot reach us by phone or fax, we have set up an e-mail contact for you:

ups@effekta.com.

You will also find additional contact addresses online at:

<http://www.effekta.com/html/kontakt.html>.

You will find the entire spectrum of our services at:

<http://www.effekta.com/html/service/html>.

A form for the exchange of inverters can be found at

http://www.effekta.com/pdf/Austausch_Solarwechselrichter_EN.zip

11. Technical data

11.1 Device specifications

		ES2200	ES3300	ES4200	ES5000
Solar inverter technology	Implementation	Sinusoidal, power source, high frequency pulse width modulation (PWM)			
	Isolation method	Execution without isolation transformer (without galvanic isolation)			
Input data for direct current	Nominal DC voltage	360 V _{DC}			
	Max. Input DC voltage	500 V _{DC}			
	Work area	120 V _{DC} to 500 V _{DC} **			
	Max. electricity per MPP tracker	14.6 A	22 A	(2 x) 14 A	(2 x) 17.65 A
	Max. power per MPP tracker	2200 W	3300 W	2100 W	2650 W
	MPPT range	150 V _{DC} to 450 V _{DC} **			
	MPP tracker	1		2	
Output data for alternating current	Nom. AC power	2000 W	3000 W	4000 W	4600 W
	Max. AC power	2200 W	3300 W	4200 W	5000 W
	Nominal AC voltage	230 V _{DC}			
	Type of output connection	Single-phase, mains connection (L, N, PE)			
	AC range	184 V _{DC} to 264.5 V _{DC} (Basis 230 V _{DC})			
	Nominal alternating current	8.69 A	13 A	17.7 A	21.7 A
	Frequency	50/60 Hz, automatic settings			
	Power factor	>0.99 with nominal alternating current			

		ES2200	ES3300	ES4200	ES5000
	Distortion factor of current (sinus deviation)	Percentage of total harmonious vibration: Below 5% percent of harmonious individual vibration: Below 3%			
Efficiency data	Max. implementation performance	> 96%			
	Euro power	> 94%			
	CEC power	> 94%			
	Standby consumption	< 7 W			
	Night-time consumption	< 0.15 W			
Environment	Operating temperature	-25 °C to +50 °C (-13 °F to 122 °F)			
	Humidity	0 to 90% (without condensation)			
Technology	Dimensions (H x W x D in mm)	430 x 455 x 170		510 x 455 x 170	
	Weight (net)	27 kg		29 kg	
	Weight (gross)	30.5 kg		32.5 kg	
	Protection class	IP65 (outdoor area)			
	Cooling	Convection			
	Alternating current connection	Screw connection			
	DC connection	MC4 plug			
Communication	Standard	RS-232			
	Optional	USB, RS-485, relay contact, SNMP			
Control panel	LCD display	Input DC voltage / input direct current / input DC power / output AC voltage / output alternating current / output frequency / output AC power / Energy output / internal temperature / cooling element temperature / status message / error message			
	LED display	Red:		Grounding fault or DC input isolation fault	

		ES2200	ES3300	ES4200	ES5000
		Yellow:		Supply conditions do not correspond to the input standard of the PV solar inverter	
		Green:		Performance of solar cells is above or below 5 % of the nominal performance of the PV solar inverter	
	Operating keys	Navigation keys / function key / enter key			
Safety	Mains	Over-/ under-voltage, over-/ under-frequency, grounding fault, DC isolation error, isolated operation			
	Short circuit	DC input: Reverse pole protection / electronic switching AC output: Output relay / electronic switching			
	EPO (emergency power off)	The PV solar inverter switches off immediately			
	Over-temperature	≤ 50 °C (122 °F) at full capacity ≥ 50 °C(122 °F) at reduced capacity			
Certification	Safety	Europe VDE0126-1-1, EN50178, IEC62103			
	EMI/EMC	EN 61000-6-1, EN 61000-6-2, EN 61000-6-3, EN 61000-6-4			

** The nominal area should be between 150 V_{DC} and 500 V_{DC} to achieve nominal power.

11.2 Block diagram of ES2200 / ES3300

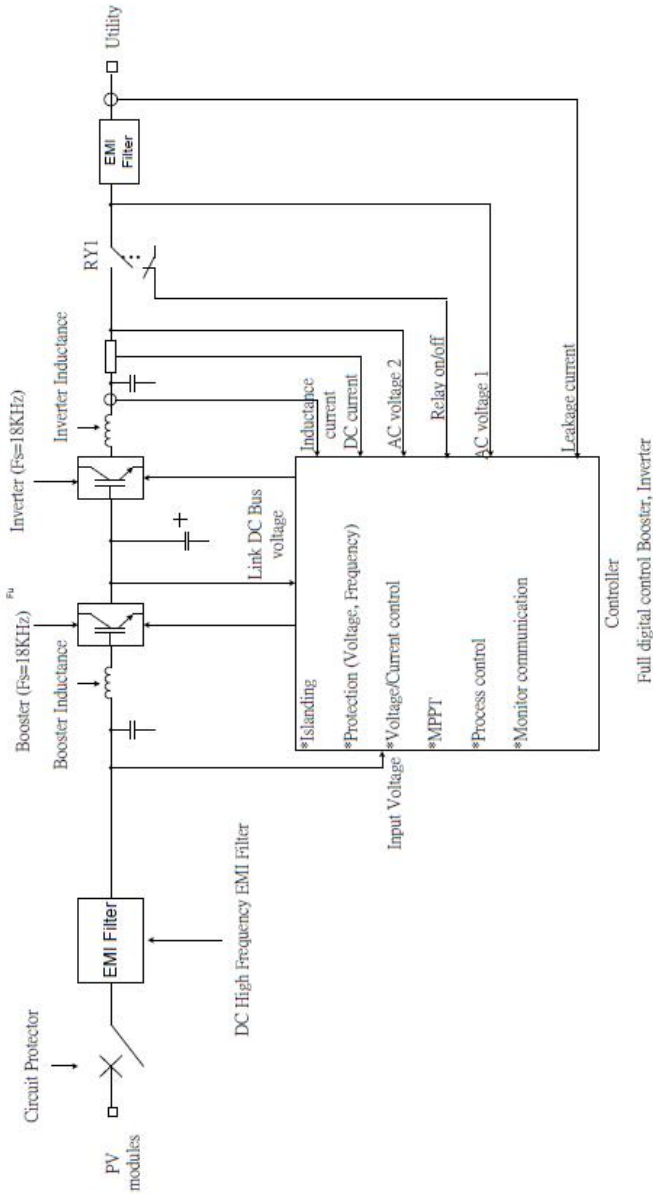



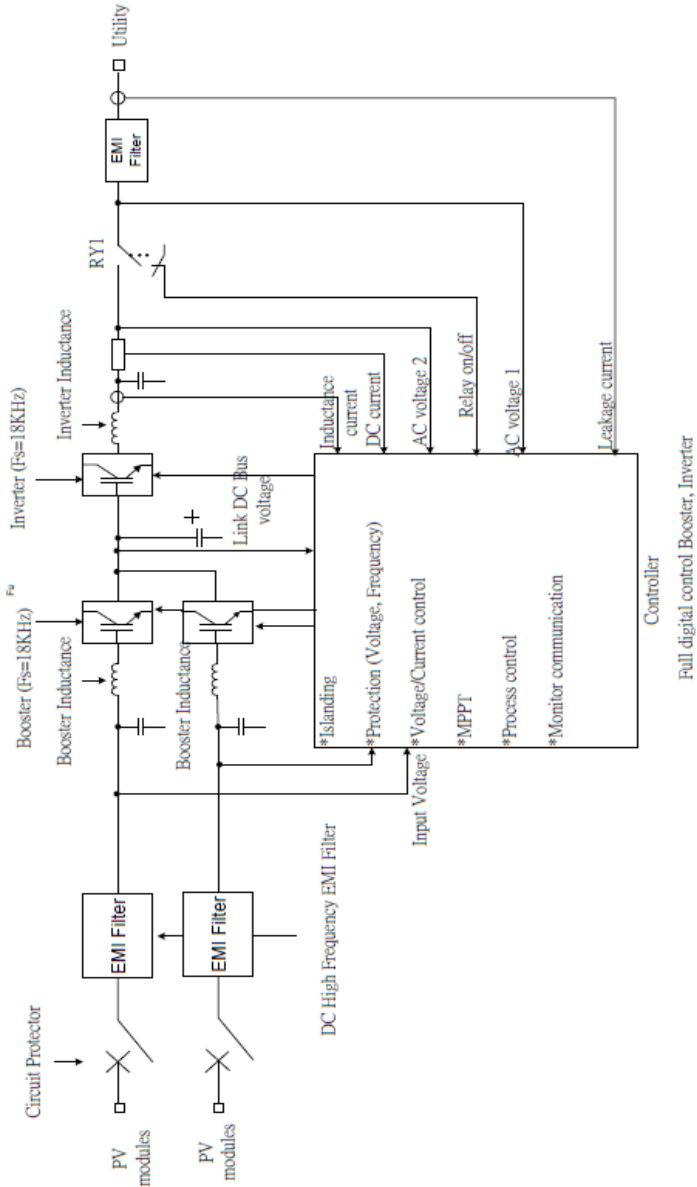



11.3 ES4200 / ES5000 Block diagram



11.4 Scope of delivery / (optional) accessories

Check the completeness of the delivery after receiving the goods:

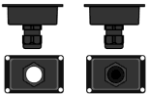
	Description	Function / View	Article number	***
1	PV solar inverter		ES2200: SLWRABSI2K0WD000 or ES3300: SLWRABSI3K0WD000 or ES4200: SLWRABSI4K0WD000 or ES5000: SLWRABSI5K0WD000	X
1	Wall mounting	 <p data-bbox="471 963 650 1011">Assembly plate for wall mounting</p>	Upon request	X
3	PV coupling plug	 <p data-bbox="426 1198 692 1246">Coupling plug PV-KST4/6II-UR</p>	PV-KST-4-6.0	X
3	PV coupling bush	 <p data-bbox="426 1417 692 1465">Coupling bush PV-KBT4/6II-UR</p>	PV-KBT-4-6.0	X





	Description	Function / View	Article number	***	
3	PV closure cap	For coupling plug	Upon request	X	
3	PV closure cap	For coupling bush	Upon request	X	
2	Cable inlets	Including assembly material	Upon request	X	
		IP65 protection consists of:	Upon request	X	
		2 covers		Upon request	X
		2 washers		Upon request	X
		8 screws		Upon request	X

*** X = included in standard scope of delivery

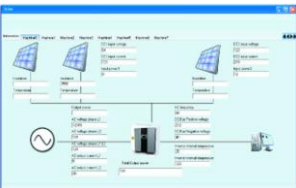
O = can be ordered as an option. Receive advice from EFFEKTA sales.

In the following, you will find a list of components that EFFEKTA Regeltechnik GmbH has approved and tested specially for this solar inverter.

Description	Function / View	Article number	***
Solar-Log™ Monitoring	 <p>Remote system</p>	SLZBSLDL21022000 (Solar Log 200 for 1 inverter) SLZBSLDL21050100 (Solar Log 500 for up to 10 inverters) SLZBSLDL21100100 (Solar Log 1000 for up to 100 inverters) More versions upon request	O
Software	 <p>"EnerSolis" software for PV solar inverter</p>	SWABENERSOLIXX00	O

	Description	Function / View	Article number	***
	RS-232 connection	RS-232 interface connection cable, approx. 170 cm (necessary for operating the software)	M2505	O
	RS-485 plug-in card	 <p>RS-485 expansion card for PV solar inverter</p>	SLZBABEK485PX000	O
	USB plug-in card	 <p>Expansion card for USB - interface</p>	SLZBABEKUSBPX000	O
	Relay plug-in card	 <p>Relay expansion card for PV solar inverter</p>	SLZBABEKRCBPX000	O
	SNMP/WEB plug-in card	 <p>SNMP/WEB expansion card for PV solar inverter</p>	SLZBABEKWEBPX000	O

*** X = included in standard scope of delivery
 O = can be ordered as an option. Receive advice from EFTEKTA sales.

12. Declaration of conformity



EC-Declaration of Conformity

Address: EFFEKTA Regeltechnik GmbH
 Rheinwaldstr. 34
 78628 Rottweil
 Germany

Product description: PHOTOVOLTAIC INVERTER

Model: ES5000
 ES4200
 ES3300
 ES2200

The above mentioned product is in delivered condition compliant with the following guidelines:

2004/108/EG: Council directive on the approximation of the laws of the member states relating to electromagnetic compatibility.

2006/95/EC: Council directive on the approximation of the laws of the member states concerning electrical equipment for use within certain voltage limits.

The conformity with the guidelines is guaranteed under application of the following norms:

Safety		Interference immunity/Interference emission:	
Number	Issue	Number	Issue
EN50178	1997	EN61000-6-1	2007
VDE0126-1-1	2006	EN61000-6-2	2005
IEC62103	2003	EN61000-6-3	2007
		EN61000-6-4	2007
		EN62040-2	2006 Category C2
		EN55022	2006 Class B
		IEC61000-4-2	2001
		IEC61000-4-3	2006
		IEC61000-4-4	2004
		IEC61000-4-5	2005
		IEC61000-4-6	2006
		IEC61000-4-8	2001
		IEC61000-4-11	2004

Limits for harmonic emissions

Number	Issue
IEC61000-3-2	2006
IEC61000-3-3	2008
IEC61000-3-11	2000
IEC61000-3-12	2004

The solar inverter corresponds in addition with the VDEW-publication:
 "Guideline for the connection and parallel operation of owner-generator plant in the low-voltage grid."

Rottweil, 21.07.2010



(Gabor Kremer / Managing Director)

With this declaration the conformity of the product with the directives is certified, but no product specifications are guaranteed. With the product documentation supplied must be read carefully.

13. Warranty and liability

13.1 Warranty conditions



The delivery receipt is considered as record of the initial purchase and should be stored in a safe place. It will be needed to make use of the warranty. If the product is passed on to another user, he has the right to the rest of the warranty period. The purchase receipt as well as the declaration should also be given to the new owner if the device is passed on.

We guarantee that this device is in a functional condition and technically conforms to the description in the appended documentation.

The warranty period for this device is 5 years from the date of purchase.

The warranty ceases to apply in the following cases:

- In the event of defects from freight damage, accident, natural catastrophes, misuse, vandalism, improper use, defective maintenance or incorrect repair by third parties.
- In the event of changes, unauthorised intervention, incorrect operation, use of another device or accessories, false installation or other modifications not approved by the manufacturer.
- In the event of failure to follow the instructions and safety information in this documentation.
- In the event of incompatibility of the product due to possible technical innovations or regulations that occur after the purchase.
- In the event of incompatibility or malfunctioning that was caused by product components that we did not install.
- In the event of developments that are related to the normal aging process of the product (wear parts).
- In the event of defects that were caused by external fixtures.
- In the event of a violation of the warranty seal.

The warranty period for parts that were replaced and/or repaired on account of the warranty expires together with the original warranty for the product.

Devices that are sent in without accessories are replaced without accessories. The return of the device is only accepted if this is done in the original packaging.

Incurred transport costs are generally not included in the warranty.

13.2 Limitation of liability

Claims to damage compensation are excluded unless they involve intent or crude negligence by EFFEKTA Regeltechnik GmbH or its employees. This does not affect liability according to the Product Liability Act. Under no circumstances are we liable for:

- claims that third parties make against you due to losses or damage.
- loss or damage to your drawings or data or the costs of recovering this data.
- economic subsequent damage (including lost profits or savings) or concomitant damage, including where we were informed of the possibility of such damage.

Under no circumstances is EFFEKTA Regeltechnik GmbH responsible for any accidental, indirect, specific, subsequent or other damage of any kind (including, without any limitation, damage related to a loss of profits, interruption of business, loss of business information, or any other losses) that result from use of the device or that are connected with the device whether they are based on the contract, damage compensation, negligence, strict liability or other claims, even if EFFEKTA Regeltechnik GmbH was informed about the possibility of such damage in advance. This exemption also includes any liability that can result from the claims of third parties against the initial purchaser.

In some countries, the exemption or the limitation of concomitant or subsequent damage is not permitted by law so that the aforementioned declaration does not enter into force.

Change Index	Date	Name	Approved
Nominal AC power of the AC output of the ES5000 changed to 4.6kVA.	01/25/2010	Sauter	R&D Management C. Nagel
Added remark about AC Switch OFF when setting up system	07/19/2010	Sauter/Gallien	R&D Management C. Nagel
Changed EC_deklaration_EN100721	07/22/2010	Gallien	R&D Management C. Nagel

EFFEKTA[®]

EFFEKTA Regeltechnik GmbH